

CR2

■ Dimensions(mm)

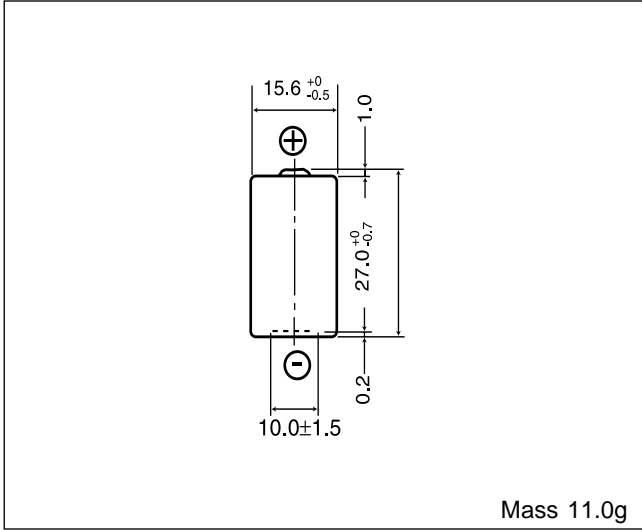

■ Specification

Nominal voltage(V)	3
Nominal capacity(mAh)	750
Continuous drain(mA)	20
Operating temperature(°C)	-40 ~ +70*

■ Temperature Characteristics

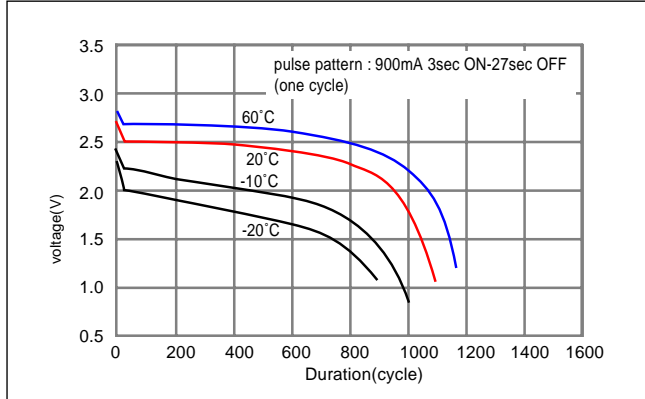

* Please consult Panasonic for use below and above -20°C to +60°C.

CR123A

■ Dimensions(mm)

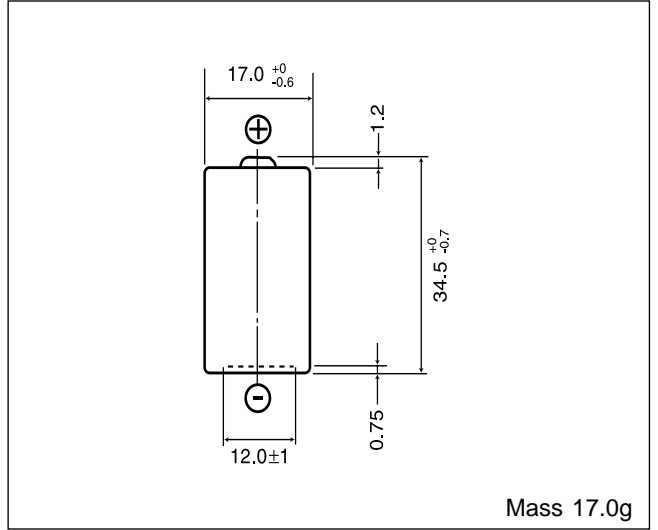

■ Specification

Nominal voltage(V)	3
Nominal capacity(mAh)	1,400
Continuous drain(mA)	20
Operating temperature(°C)	-40 ~ +70*

■ Temperature Characteristics

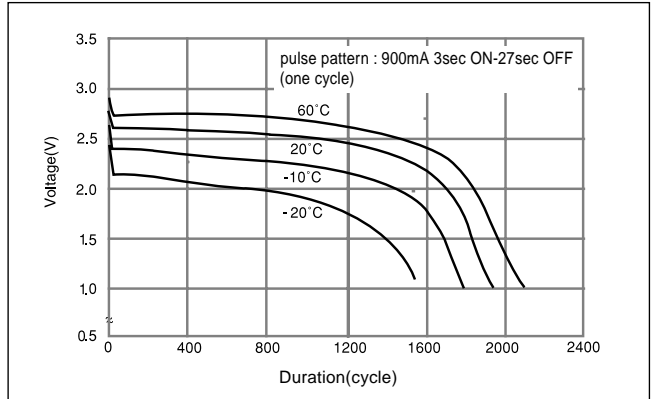

* Please consult Panasonic for use below and above -20°C to +60°C.