

Dimensions

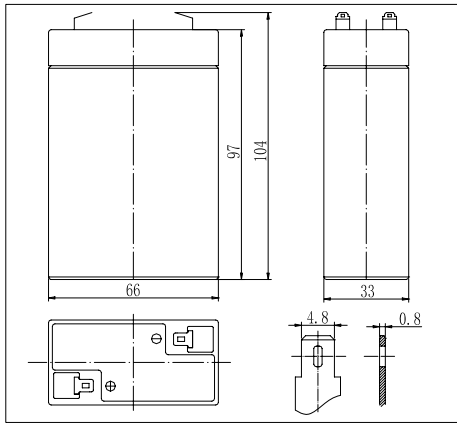

Specifications

Nominal Voltage		6 V
Capacity(20HR, 25°C)		2.8Ah
Dimension	Length	66mm (2.60inch)
	Width	33mm (1.30inch)
	Height	97mm (3.82inch)
	Total Height	104mm (4.09inch)
Approx. Weight		0.60kg (1.32lbs)
Internal resistance (Fully charged, 25°C)		Approx. 25mΩ
Capacity affected by temperature (20HR)	40°C	102%
	25°C	100%
	0°C	85%
	-15°C	65%
Self-discharge (25°C)	3 month	Remaining Capacity: 91%
	6 month	Remaining Capacity: 82%
	12 month	Remaining Capacity: 65%
Nominal operating temperature		25°C ± 3°C (77°F ± 5°F)
Operating temperature range		-15°C ~ 50°C (5°F ~ 122°F)
Float charging voltage(25°C)		6.80 to 6.90V
Cyclic charging voltage(25°C)		7.25 to 7.45V
Maximum charging current		0.84A
Terminal material		Copper
Maximum discharge current		42A(5 sec.)

- ◆ Absorbent glass mat technology;
- ◆ Recognized by UL & CE;
- ◆ ABS container.

Charging Characteristics(25°C)

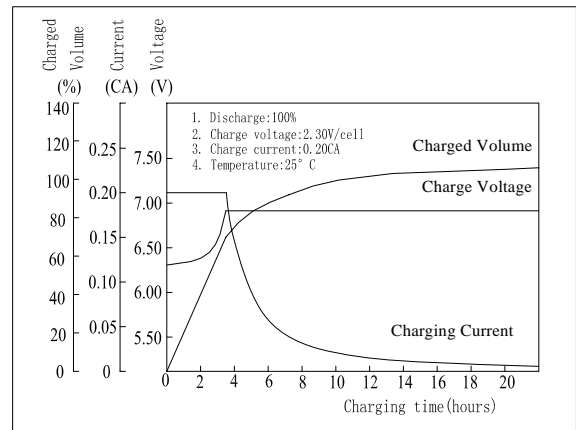

Cycle Life(25°C)

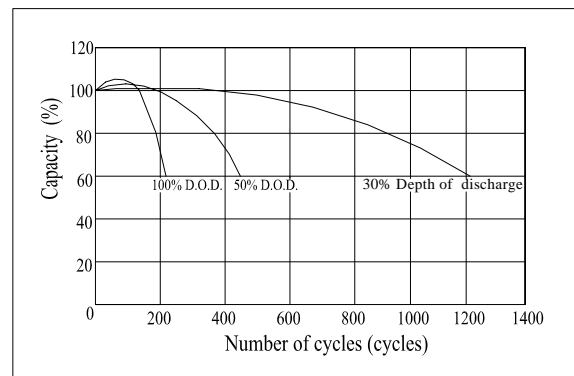

Note: Floating life at 20°C designed for 3 to 5 years.

Constant Current Discharge Characteristics (A, 25°C)

F.V/TIME	5min	10min	15min	30min	60min	3h	5h	10h	20h
4.80V	11.5	7.02	5.50	3.10	1.83	0.71	0.46	0.26	0.14
5.10V	10.9	6.84	5.28	2.98	1.76	0.70	0.45	0.26	0.14
5.40V	10.2	6.43	5.02	2.83	1.67	0.69	0.44	0.25	0.14

Constant Power Discharge Characteristics (Watt, 25°C)

F.V/TIME	5min	10min	15min	30min	60min	3h	5h	10h	20h
4.80V	64.2	40.6	31.4	17.8	10.6	4.22	2.73	1.52	0.85
5.10V	61.0	38.6	30.1	17.1	10.2	4.16	2.69	1.51	0.85
5.40V	57.3	36.3	28.6	16.2	9.7	4.07	2.63	1.51	0.84